

Pressure Vacuum Relief Valve

Top mounted, end of line, spring loaded
Model 101



Product Description

Storagetech™ 's Model 101 Top Mounted, End of Line, Spring Loaded Pressure Vacuum Relief Valve is designed to protect the tank from excessive internal pressure during operation. The spring-loaded pallet and diaphragm assembly is held tightly against a seal to prevent the loss of vapour to atmosphere in the closed position. As the internal pressure in the tank increases, due to product filling or vapour development, the set pressure is reached, accordingly, the diaphragm shall be opened and discharge the gas to atmosphere. Model 101 set pressure can be arranged as per storage tank requirements and the valve will reseal when internal pressure returns to below set pressure. The vacuum pallet and diaphragm assembly is similarly maintained in the closed position. As the internal pressure in the tank reduces, due to emptying vacuum conditions occurs, the balance between the tank pressure and the external atmospheric pressure changes. Accordingly when the set pressure of the unit is reached, the diaphragm opens to vacuum air content and rebalance the internal pressure. Storagetech Valves Activated as close as to set pressures, less than 10% of set pressures, ensuring accurate pressure management and isolate emission losses perfectly.

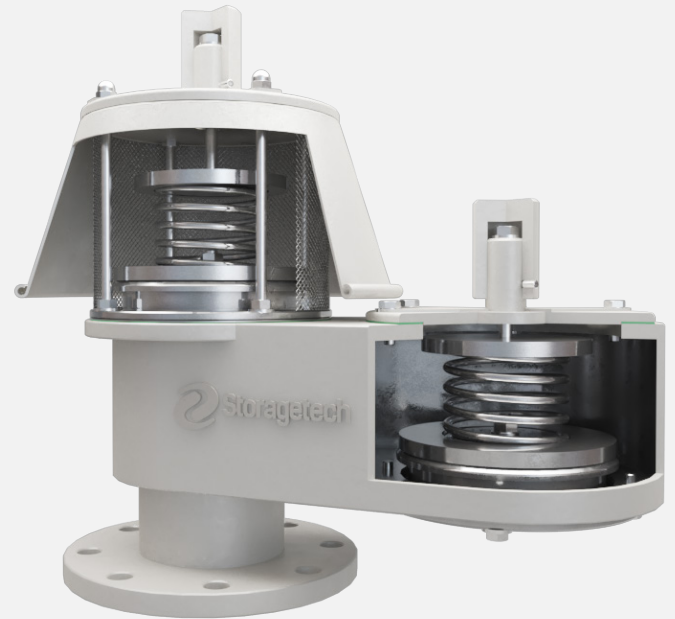

With 40 years of experience, Storagetech™ PVV systems offer effective solutions against unwanted evaporation and vacuums that may occur in tanks.

Thanks to PVV solutions produced completely in accordance with international norms, Storagetech™ is a reliable, sustainable and effective solution partner for your investments.

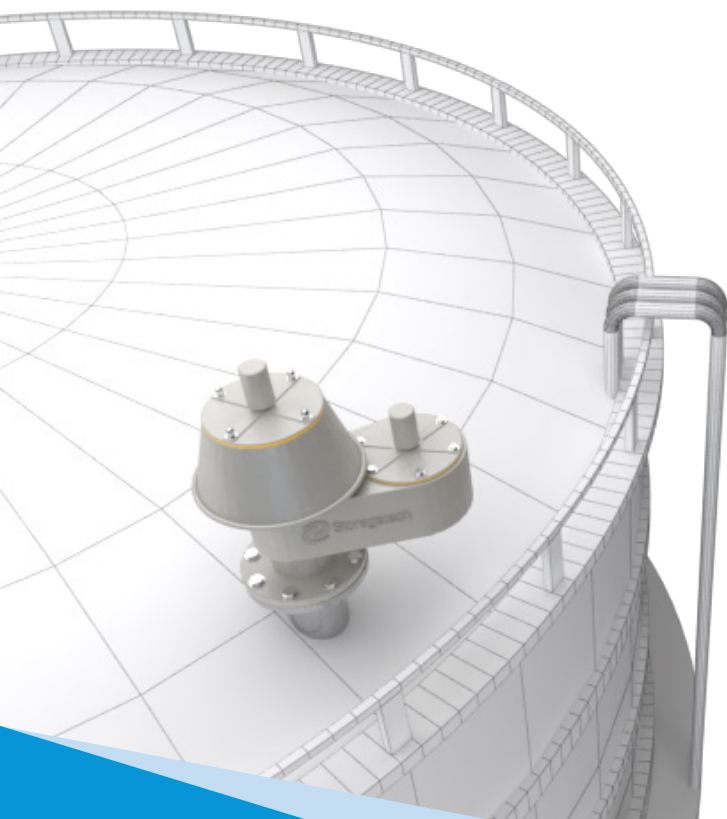

Construction

Standard Sizes	2" to 12" (DN50 to DN300) Further sizes are applicable upon request.
Flanges	ANSI, DIN, JIS, BSP
Body	Carbon Steel, Stainless Steel or Aluminium
Seals	Klingrit, Nitrile, Viton, PTFE
Pallet	Stainless Steel AISI 304/316
Springs	Stainless Steel
Paint Finish	1. Customer Specification 2. Powder Coating, Colour RAL 9006 3. Epoxy Paint, Colour RAL 9006 4. PTFE Coating
ATEX Cert	II 1/2 G Ex h IIB Ga/Gb

Setting Range

Pressure Spring-loaded +35 mbar and +1000 mbar (+14 inch W.C. and +400 inch)

Vacuum Spring-loaded -35 mbar and -800 mbar (-14 inch W.C. and -320 inch)

*Different settings can be applicable as per request

Ambient temp. -20°C to +60°C

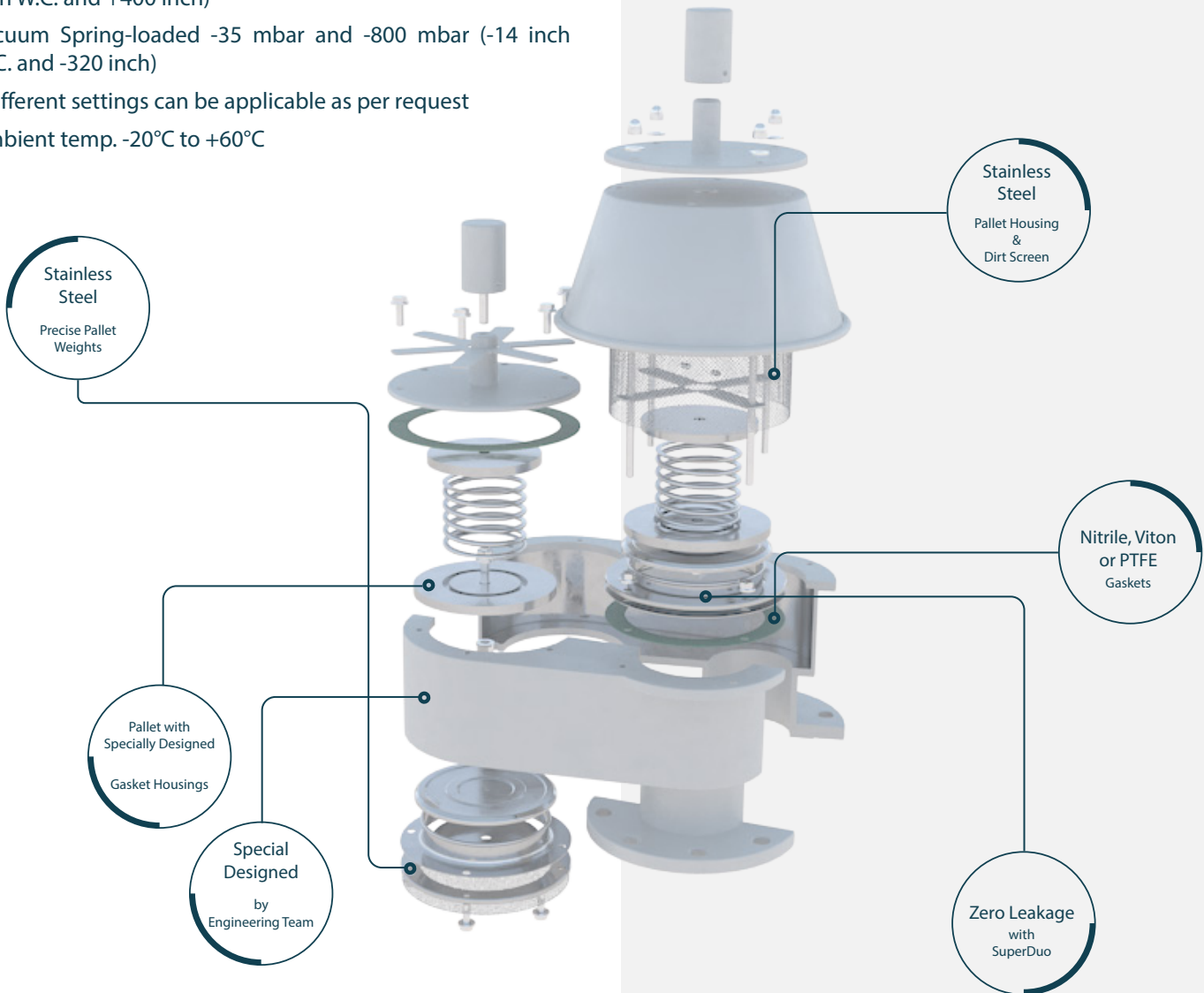

Key Features

Easy to install. Do not need a special tool or experience.

Light weight construction.

Quick and easy to install, inspect and clean.

Any grade materials are available.

Has stainless steel pallets.

Large weatherhood provides maximum airflow.

Internal materials are resistant to winter conditions.

Special designs can be achievable upon request to meet individual specifications.

Vacuum and relief cases can be managed effectively as per the set requirements of bulk storage tank.

Super Duo technology provides extra curves and perfect seating with zero leakage.

Set values can be arranged as per the site conditions, no need supervising.

Diaphragm is manufactured from PTFE material to prevent possibility of ice formation and sticky residues hindering the valve from opening, while the pallet assembly moves freely on guide posts.

Design, manufacturing and test according to EN ISO 80079-36.

Breathing requirements are fulfilled according to API 2000 7th Edition.

PTFE, XYLAN, Rubber lining, etc. coating options are available.

Technical Drawing

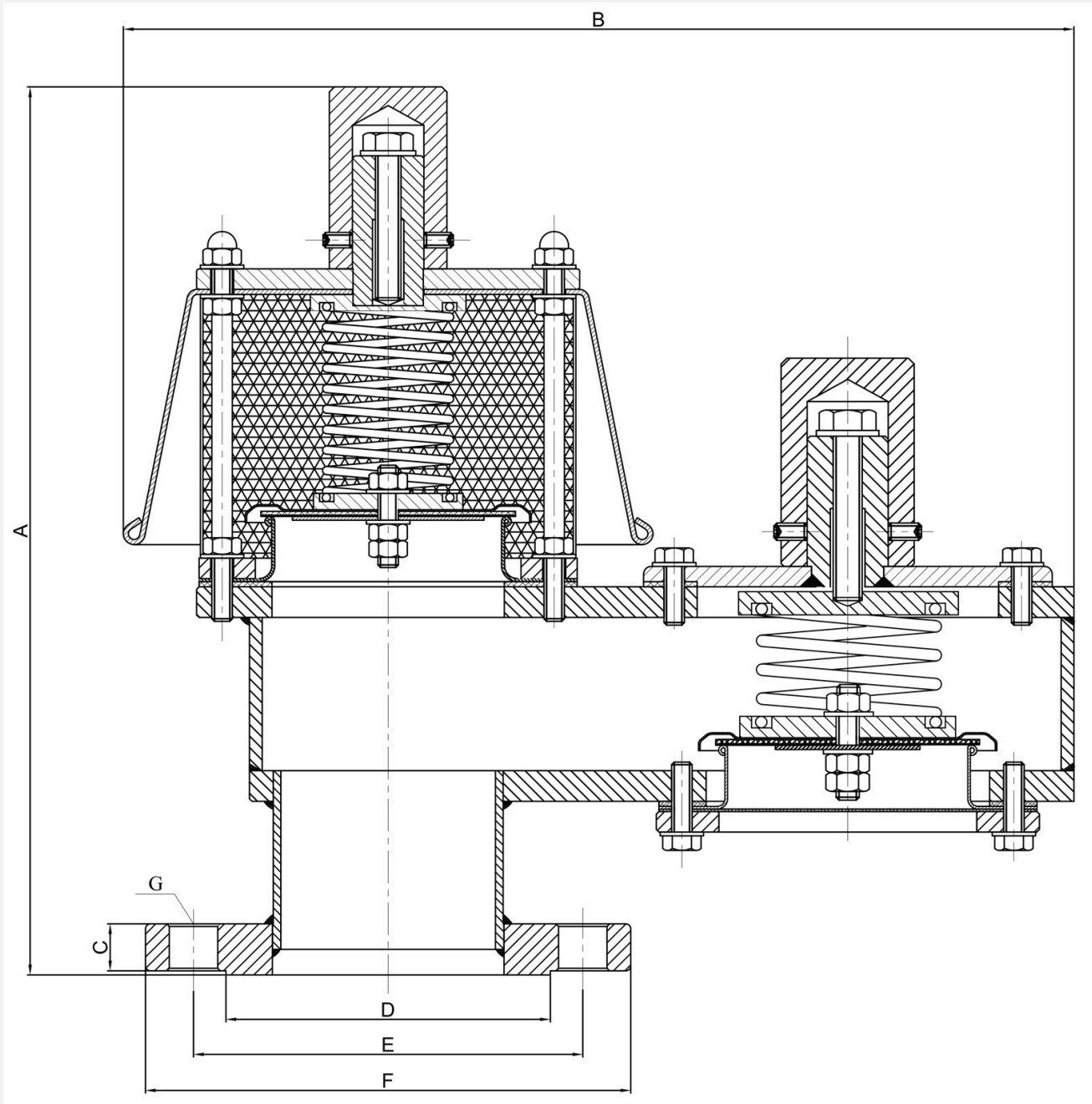

Weight & Dimensions

SIZE		A	B	C	D		E		F		G		TOTAL WEIGHT
NPS	DN				ANSI 150# RF	DN	ANSI 150# RF	DN	ANSI 150# RF	DN	ANSI 150# RF	DN	(kg)
2"	50	330	270	18	Ø92.1	Ø102	Ø120.6	Ø125	Ø152	Ø165	Ø19x4	Ø18x4	13,5
3"	80	347	350	18	Ø127	Ø138	Ø152.4	Ø160	Ø190	Ø200	Ø19x4	Ø18x8	19,5
4"	100	433	475	18	Ø157.2	Ø158	Ø190.5	Ø180	Ø229	Ø220	Ø19x8	Ø18x8	27,1
6"	150	464	615	18	Ø215.9	Ø212	Ø241.3	Ø240	Ø279	Ø285	Ø22.2x8	Ø22x8	45,4
8"	200	509	807	18	Ø269.9	Ø268	Ø298.4	Ø295	Ø343	Ø340	Ø22.2x8	Ø22x12	75,3
10"	250	607	908	18	Ø323.8	Ø320	Ø362	Ø355	Ø406	Ø405	Ø25.4x12	Ø26x12	97,9
12"	300	645	1020	18	Ø381	Ø378	Ø431.8	Ø410	Ø483	Ø460	Ø25.4x12	Ø26x12	126,1

Flow Capacity Tables

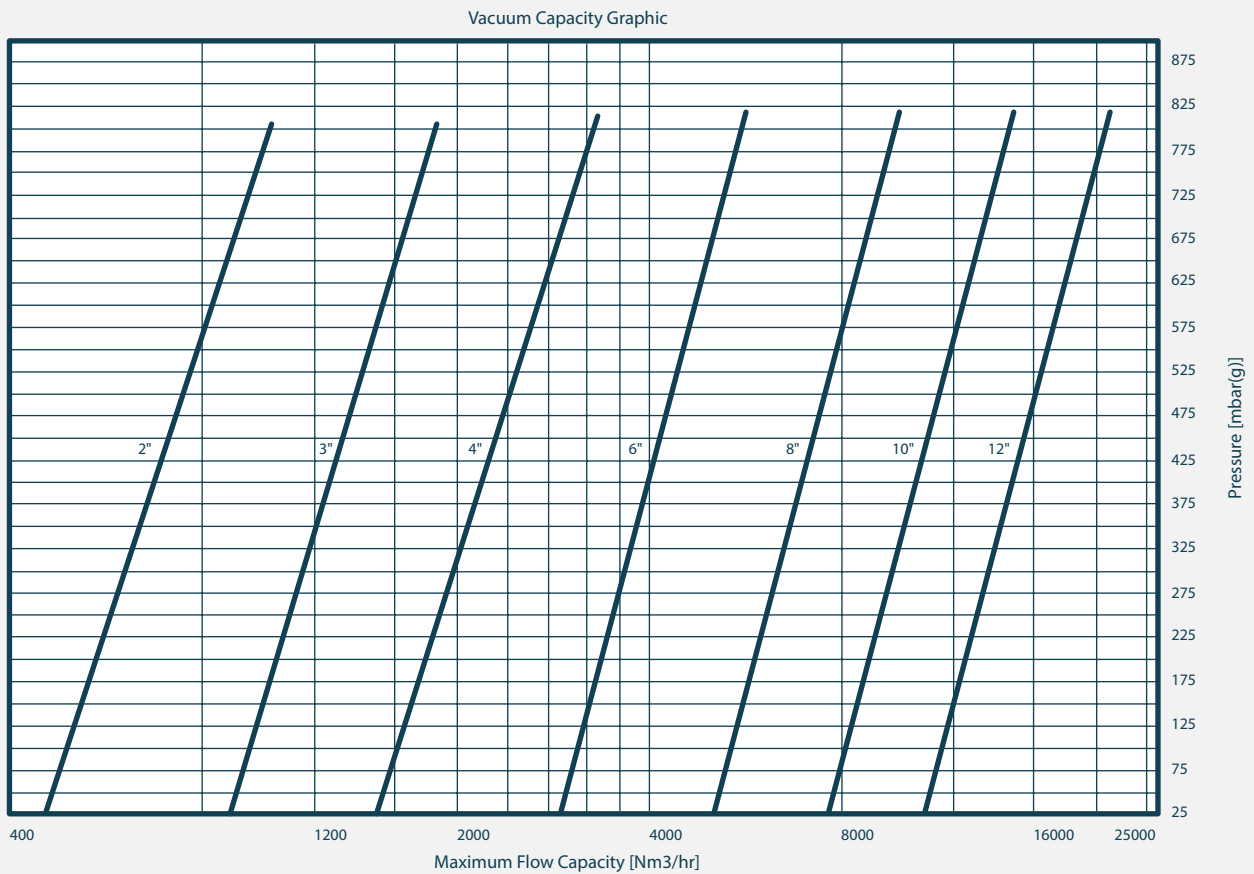
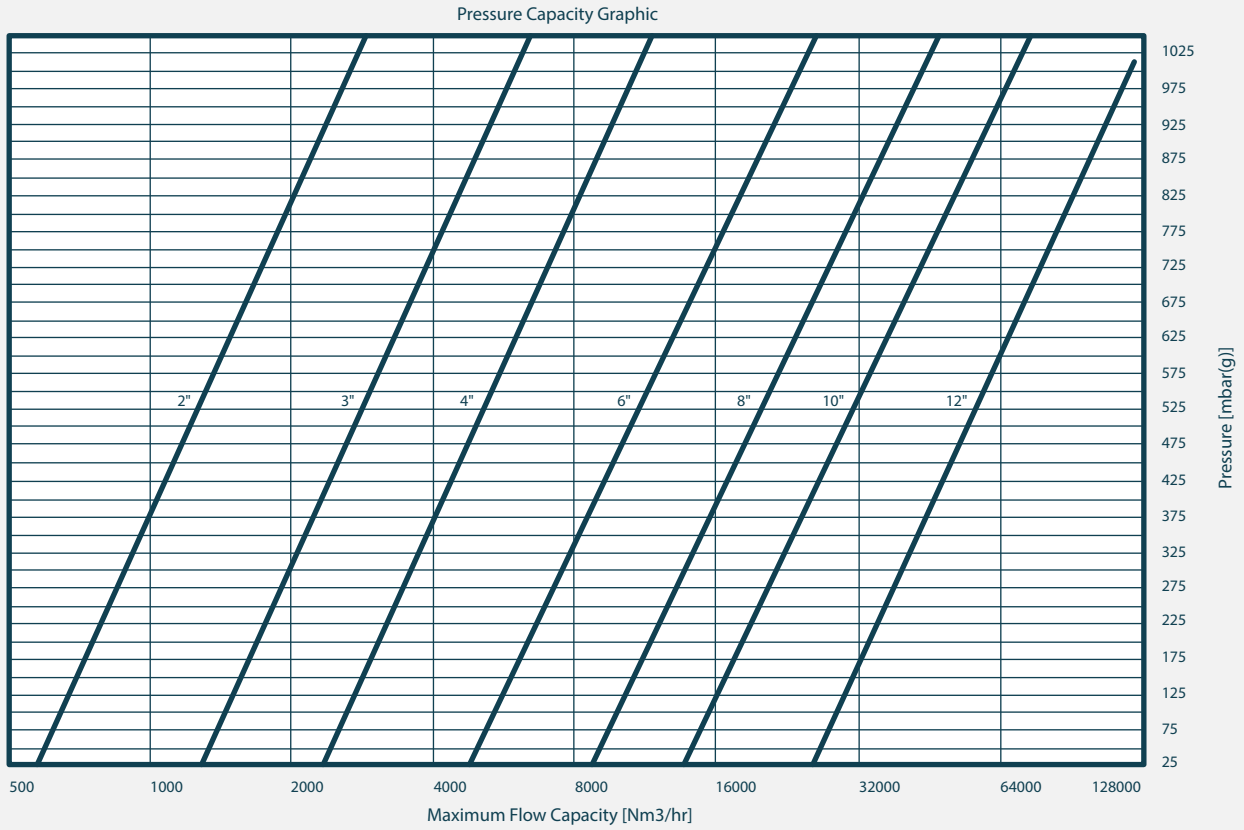

Flow Capacity Tables

PRESSURE RELIEF CAPACITIES [Nm³/hr] - OVERPRESSURE SPRING

mbar (g)	2"		3"		4"		6"		8"		10"		12"	
	20%	40%	20%	40%	20%	40%	20%	40%	20%	40%	20%	40%	20%	40%
40	569	585	1282	1320	2277	2344	5090	5239	9111	9377	14260	14676	20533	21131
50	637	655	1434	1476	2546	2620	5721	5887	10185	10481	15936	16400	22948	23617
60	697	718	1569	1614	2788	2869	6264	6447	11153	11478	17453	17962	25130	25862
70	752	774	1694	1744	3011	3098	6764	6961	12043	12394	18845	19394	27133	27924
80	804	828	1811	1863	3217	3310	7229	7439	12869	13244	20139	20725	28997	29841
90	854	879	1921	1977	3411	3511	7665	7889	13645	14043	21352	21974	30744	31640
100	899	925	2024	2083	3595	3699	8075	8310	14379	14798	22500	23156	32397	33340
120	985	1013	2216	2280	3935	4049	8842	9099	15739	16198	24627	25345	35463	36496
140	1062	1093	2391	2460	4246	4369	9543	9821	16989	17484	26584	27359	38278	39393
160	1135	1168	2554	2629	4537	4669	10195	10492	18149	18677	28397	29224	40891	42082
180	1203	1238	2708	2787	4809	4949	10805	11119	19236	19797	30097	30973	43342	44605
200	1267	1304	2852	2935	5065	5212	11382	11713	20262	20852	31709	32632	45650	46979
240	1386	1427	3120	3211	5541	5703	12451	12813	22166	22811	34680	35690	49940	51394
280	1496	1539	3365	3463	5977	6151	13430	13821	23908	24605	37410	38499	53868	55437
300	1547	1592	3481	3583	6182	6362	13892	14296	24730	25451	38697	39824	55702	57325
350	1668	1716	3750	3859	6665	6859	14978	15415	26665	27441	41727	42943	60080	61830
400	1780	1832	4006	4122	7114	7321	15986	16451	28457	29286	44527	45824	64118	65985
450	1885	1940	4242	4365	7532	7752	16926	17419	30225	31106	47151	48525	67891	69869
500	1983	2041	4463	4593	7927	8158	17812	18331	31709	32632	49617	51062	71441	73522
550	2076	2137	4673	4809	8300	8541	18648	19191	33201	34168	51953	53466	74805	76984
600	2165	2228	4873	5015	8654	8906	19446	20013	34618	35627	54168	55745	77998	80270
650	2251	2316	5063	5211	8993	9255	20207	20795	35973	37021	56290	57929	81050	83410
700	2331	2399	5246	5399	9316	9588	20935	21545	37265	38351	58319	60017	83976	86422
750	2409	2479	5422	5580	9628	9909	21636	22266	38517	39639	60265	62021	86762	89289
800	2483	2556	5591	5754	9929	10218	22310	22960	39717	40874	62149	63959	89484	92091
850	2554	2629	5754	5921	10218	10515	22959	23627	40870	42061	63958	65821	92091	94774
900	2627	2703	5911	6083	10498	10804	23588	24275	41993	43216	65710	67624	94611	97366
950	2694	2773	6064	6240	10769	11082	24197	24902	43076	44330	67405	69369	97051	99877
1000	2762	2843	6216	6397	11036	11358	24800	25523	44149	45435	69099	71111	99467	102364

Flow Capacity Tables

VACUUM RELIEF CAPACITIES [Nm³/hr] - UNDERPRESSURE SPRING

mbar (g)	2"		3"		4"		6"		8"		10"		12"	
	20%	40%	20%	40%	20%	40%	20%	40%	20%	40%	20%	40%	20%	40%
40	556	587	1031	1090	1813	1915	3138	3315	5475	5785	8260	8728	11686	12347
50	567	599	1052	1112	1849	1954	3200	3381	5584	5900	8425	8902	11920	12594
60	578	611	1073	1134	1886	1993	3264	3449	5696	6018	8594	9080	12158	12846
70	590	623	1095	1156	1924	2032	3330	3518	5810	6139	8766	9262	12401	13103
80	602	636	1116	1180	1962	2073	3396	3588	5926	6261	8941	9447	12649	13365
90	614	648	1139	1203	2001	2115	3464	3660	6045	6387	9120	9636	12902	13632
100	626	661	1162	1227	2041	2157	3533	3733	6165	6514	9302	9829	13160	13905
120	639	675	1185	1252	2082	2200	3604	3808	6289	6645	9488	10025	13423	14183
140	651	688	1208	1277	2124	2244	3676	3884	6415	6778	9678	10226	13692	14467
160	664	702	1233	1302	2166	2289	3750	3962	6543	6913	9872	10430	13966	14756
180	678	716	1257	1328	2210	2335	3825	4041	6674	7051	10069	10639	14245	15051
200	691	730	1282	1355	2254	2381	3901	4122	6807	7192	10270	10852	14530	15352
240	705	745	1308	1382	2299	2429	3979	4204	6943	7336	10476	11069	14820	15659
280	726	767	1347	1424	2368	2502	4099	4331	7152	7556	10790	11401	15265	16129
300	748	790	1388	1466	2439	2577	4222	4460	7366	7783	11114	11743	15723	16613
350	770	814	1429	1510	2512	2654	4348	4594	7587	8017	11447	12095	16195	17111
400	793	838	1472	1556	2587	2734	4479	4732	7815	8257	11791	12458	16681	17625
450	817	864	1516	1602	2665	2816	4613	4874	8049	8505	12144	12832	17181	18154
500	842	889	1562	1650	2745	2900	4751	5020	8291	8760	12509	13217	17696	18698
550	875	925	1624	1716	2855	3016	4941	5221	8622	9110	13009	13745	18404	19446
600	910	962	1689	1785	2969	3137	5139	5430	8967	9475	13529	14295	19140	20224
650	947	1000	1757	1856	3088	3262	5345	5647	9326	9854	14071	14867	19906	21033
700	985	1040	1827	1931	3211	3393	5558	5873	9699	10248	14633	15462	20702	21874
750	1024	1082	1900	2008	3340	3529	5781	6108	10087	10658	15219	16080	21530	22749
800	1065	1125	1976	2088	3473	3670	6012	6352	10490	11084	15828	16723	22392	23659

Product Recommendations



Biogas Safety Selector Valve (SSV)

Model: 250

The Storagetech Biogas Safety Selector Valve (SSV) is an advanced, cost-effective alternative to traditional three-way plug valves, designed for seamless operation in biogas systems. It enables smooth switching between Pressure and Vacuum Relief Valves (PVRs) with Flame Arrestors, ensuring uninterrupted operation during maintenance.



Pressure Vacuum Relief Valve With Flame Arrestor

End-Of-Line,
Weight Loaded,
Combination,
Atmospheric Deflagration
Proof

Model: 330

Storagetech™'s Model 330 Pressure Vacuum Relief Valve with Flame Arrestor provides protection to bulk storage tanks and vessels from over and under pressurization.

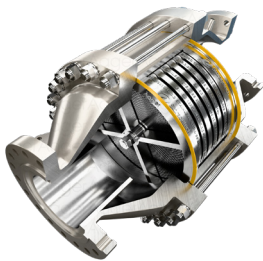

Flame Arrestor

Vertical,
In-Line,
Detonation

Model: 320

Storagetech™'s Model 320 In-line Detonation Flame Arrestor (also called flame arrestor or fire arrestor) is designed for installation in gas pipelines. Detonation occurs when a flame travelling through the pipeline reaches supersonic velocities, usually as a result of the pipeline configuration or pipeline surface roughness. Changes in gas density and pressure causes the flame velocity to metamorphose from subsonic to supersonic.



Flame Arrestor

Horizontal,
In-Line,
Detonation

Model: 321

Storagetech™'s Model 321 In-line Detonation Flame Arrestor (also called flame arrestor or fire arrestor) is designed for installation in gas pipelines. Detonation occurs when a flame travelling through the pipeline reaches supersonic velocities, usually as a result of the pipeline configuration or pipeline surface roughness. Changes in gas density and pressure causes the flame velocity to metamorphose from subsonic to supersonic.

Äger GmbH

Germany Head Office + R&D + Sales
Herzogspitalstraße 24
Munich 80331
Germany
+49 (0) 89 1250 15240
www.aager.de
sales@aager.de

Turkey Head Office + Sales
Ağaoğlu My Office 212
No: 3 B Blok /175
PK 34218 Güneşli – Bağcılar
Istanbul / Turkey
+90 212 485 40 07
+90 212 485 40 42
sales@aager.de
sales@storagetech.de

Turkey Factory + Engineering + R&D + Sales
Mersin Tarsus OSB.13.CD.NO:7
PK: 33540 Mersin, Turkey
+90 324 676 44 04
+90 324 676 44 03
sales@aager.de
sales@storagetech.de

UAE Sales + Warehouse
Jumeirah Lake Towers, X2 Tower 1906
P.O. Box: 123661 Dubai, UAE
+971 4 450 8051
+971 4 450 8041
sales@storagetech.de

KSA Sales + Warehouse
Q1-14, The Business Quarter,
King Faisal Road,
Al Khalidiyyah Al Janubiyah,
Dammam, KSA
+966138163471
sales@storagetech.de



data sheet series

PVRV-Topmounted, end of line,
spring loaded

Revision No: 02
ST-DS-PVRV.S-02.21/V2
storagetech.de

February 2021

Storagetech™ Website
QR Code

